

Warmup

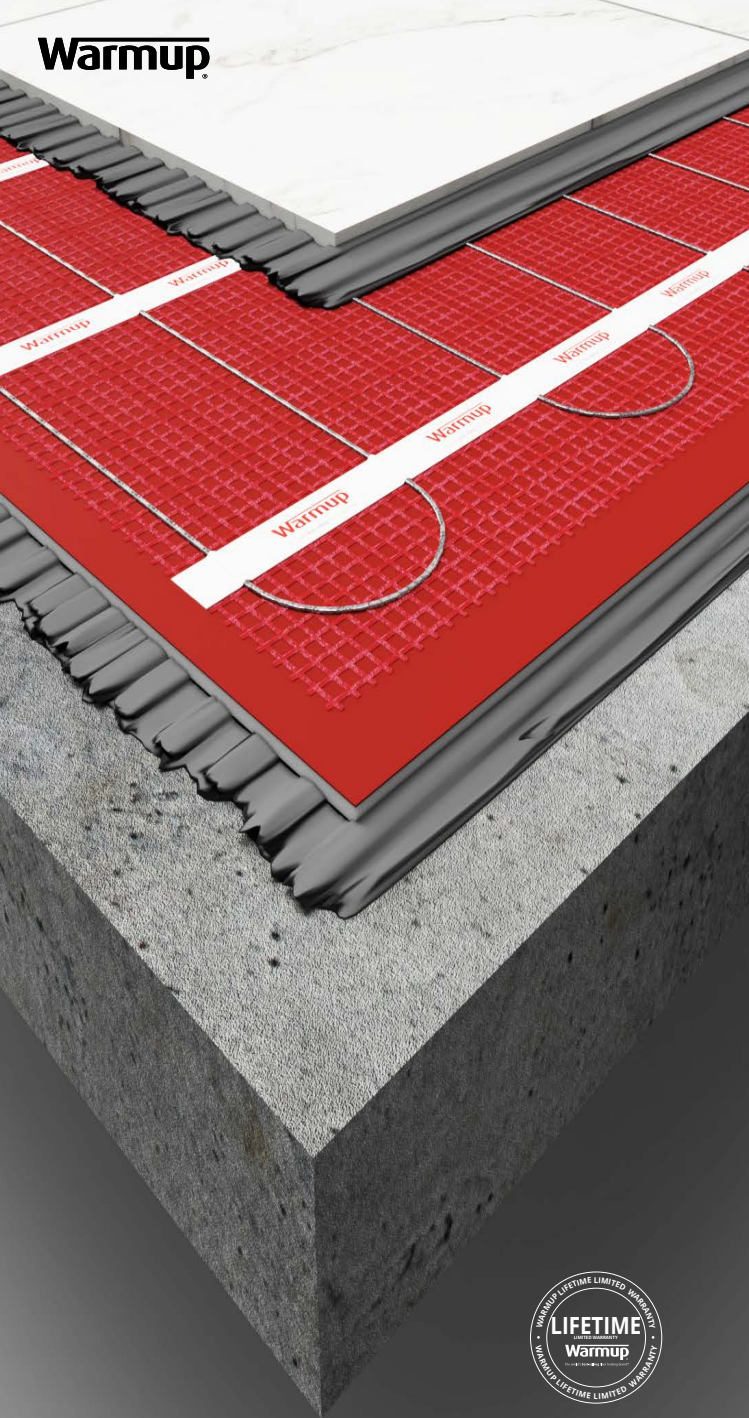

Warmup StickyMat
Installation manual



SAFETY NetTM
Installation-Guarantee



Warmup



6 iETM WiFi Thermostat

The smartest, most efficient way to control
the world's best selling floor heating

Table of Contents

Installation summary	4
Safety information	6
Components available from Warmup	9
Step 1 - Electrical supply	10
Typical floor build-ups	12
Recommended subfloor - Tile floor finishes	12
Recommended subfloor - All floor finishes	13
Step 2 - Subfloor considerations	14
Step 3 - Subfloor preparation	15
Step 4 - Layout planning.....	16
Step 5 - StickyMat installation.....	18
Step 6 - Select floor covering	20
Step 7 - Lay the floor covering	21
- Tile floor finishes	21
- All floor finishes	22
Step 8 - Connect the thermostat	23
- Connect the thermostat (Load exceeding 16 Amps)	24
Troubleshooting	26
Performance troubleshooting	28
Testing information	30
Technical specifications	32
System performance	34
Warranty	36
Layout plan	38
Control card.....	39

Warmup® floor heating systems are designed so that installation is quick and straight forward, but as with all electrical systems, certain procedures must be strictly followed. Please ensure that the correct system(s) for the area to heat has been selected. Warmup plc, the manufacturer of the Warmup StickyMat system, accepts no liability, expressed or implied, for any loss or consequential damage suffered as a result of installations which in any way contravene the instructions that follow.

It is important that before, during and after installation that all requirements are met and understood. If the instructions are followed, there should be no problems. If assistance is required at any stage, please contact the helpline.

A copy of this manual, wiring instructions and other helpful information on our website:

www.warmup.ie

Installation summary

Please also read the full instructions that follow this section.



- Make electrical provision for the system (30 mA RCD, overcurrent protection, 35 mm deep electrical wall boxes, trunking).



- The subfloor should be pre-insulated unless it is an intermediate floor.
- The subfloor should be prepared to a surface regularity where the maximum departure from a 2 m straight edge, resting under its own weight on the subfloor is 3 mm (SR1)



- The subfloor must be smooth, dry, frost-free, solid, suitably weight-bearing and dimensionally stable.
- Referring to its instructions, prime the subfloor using Warmup primer.



- We recommend installing Warmup Ultralight for optimum performance referring to its instructions.
- If planning to self-level over the StickyMat system then install perimeter strip around the perimeter of the room to allow for differential movement between finished floor level and walls.

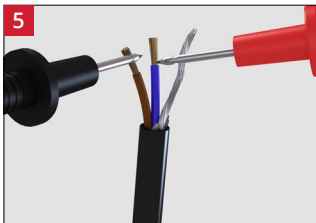

- Test and record the resistance of the system ensuring it is within the range set out in the Reference Resistance Band table.

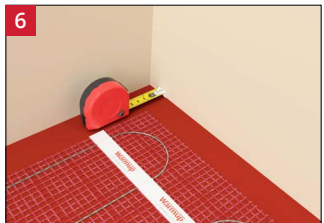

- The system should be installed 40 mm in from the edge of the heated area or penetrations through the floor.

Installation summary

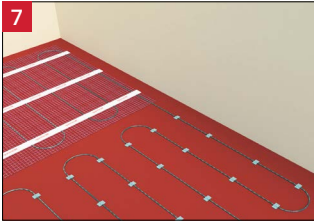

- Cut, turn and affix the heating mat to the subfloor using self-adhesive mesh or double sided tape.
- Any loose heating cable removed from the mesh must be installed at no less than 50 mm intervals and tab taped in place.
- Install the floor sensor centrally between the two closest runs of the heating cable.

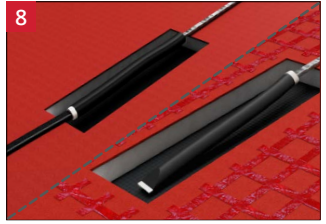

- Channel a groove in the subfloor for the coldtail & termination joints, enabling them to fit flush with the top of the system.



DO NOT tape over the manufactured joints. They must be fully embedded within the tile adhesive or levelling compound being laid over.

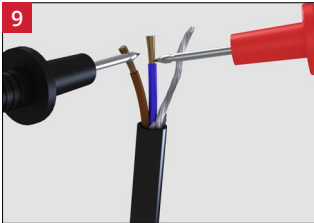

- Test and record the resistance of the system after installation and check against the previous value to ensure no damage has occurred.



- Lay tiles or levelling compound over the system.
- The system, including its joints, must be wholly within the adhesive or levelling compound and not exposed.

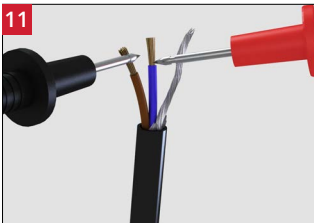















- Test and record the resistance of the system after tiling and check against previous values to ensure no damage has occurred.













- Install the Warmup thermostat referring to their installation instructions. The StickyMat system must be connected to and controlled with a thermostat and sensor.

Safety information

-  Perform a site inspection. Measurements and other requirements on site must match working drawings.
-  Inspect the site for possible hazards that could damage the system, such as nails, staples, materials or tools. Ensure that during the course of the installation no damage is caused to the system by falling or sharp objects.
-  Ensure all electrical connections conform to the current national wiring regulations. Final connections to the main electricity supply **MUST** be completed by a qualified electrician.
-  Ensure the heating mat is protected a dedicated 30 mA RCD/RCBO or an existing RCD/RCBO). Time delay RCD's must not be used.
-  Ensure that the control card at the back of the manual is completed and fixed at the consumer unit along with any plans and electrical test records as per the current national wiring regulations.
-  The subfloor should be pre-insulated unless it is an intermediate floor and be prepared to a surface regularity where the maximum departure from a 2 m straight edge, resting under its own weight on the subfloor is 3 mm (SR1). The subfloor must be smooth, dry, frost-free, solid, suitably weight-bearing and dimensionally stable.
-  Prepare timber subfloors for tiling in accordance with local national tiling standards, to prevent damage to the system.
-  Install the floor sensor centrally between the two closest parallel runs of heating cable and away from other heat sources such as hot water pipes, lighting fixtures, chimneys etc.
-  Before installing the floor finish, its suitability for use with underfloor heating and its maximum operating temperature should be checked against required operating conditions. Ensure the heat output of the floor meets requirements.
-  Install floor coverings which are at least 5 mm thick. For floor coverings other than tile, lay a minimum 10 mm levelling compound over the heating mat first. Check with flooring manufacturer for suitability with floor heating.
-  Ensure adhesives, grouts, levelling compound used is compatible with underfloor heating and suitable for application onto electric underfloor heating systems.
-  Underfloor heating performs the most efficiently with conductive, low resistance floor finishes such as stone and tiles. Consideration should be given to the thermal resistance and temperature limits of the chosen floor covering and its impact on the system heat output.
-  Ensure all furniture installed over underfloor heating has feet, maintaining a minimum 50 mm ventilated space above the floor to allow heat flow into the room.
-  This appliance can be used by children aged from 8 years and above and persons with reduced physical, sensory or mental capabilities or lack of experience and knowledge if they have been given supervision or instruction concerning use of the appliance in a safe way and understand the hazards involved. Children shall not play with the appliance. Cleaning and user maintenance shall not be made by children without supervision.

Safety information

-  DO NOT cut, shorten or extend the heating cable, it must be fully installed within the layer of tile adhesive or levelling compound. The heating cable must not be installed over another cable run, over coldtails or the floor sensor.
-  DO NOT leave surplus heating mat rolled up under units or fixtures, use the correct size system for the installation.
-  DO NOT attempt a DIY repair if the heating mat is damaged, contact Warmup for assistance.
-  DO NOT tape over manufactured joints or the floor sensor tip. Doing so will cause air pockets and damage the heating cable and sensor. The manufactured joints must be covered with a full bed of flexible adhesive directly beneath the heated floor.
-  DO NOT place items above the heating system which, when combined with the floor finish, have a thermal resistance of more than 0.15 m²K/W. Such items include bean bags, heavy rugs, flat furniture, animal beds or mattresses.
-  DO NOT bend the heating cable under 25 mm radius.
-  DO NOT switch on the heating mat until the tile adhesive and grout has fully cured. DO NOT use the system to accelerate the drying process of the adhesive or levelling compound.
-  DO NOT install the heating cable in temperatures less than - 10 °C.
-  DO NOT use staples to secure the heating cable to the subfloor.
-  DO NOT install the system on irregular surfaces such as on stairs or walls.
-  DO NOT install the system in locations where they will increase the ambient temperature of any existing electrical installation above its rated value.

WARNING! Radiant direct floor heating system. Risk of shock or fire

Failure to comply with local wiring regulations or the contents of this manual may result in electric shock or fire!



Warmup StickyMat is an electric underfloor heating system designed for use within the adhesive layer under tiles or within a levelling compound under other floor finishes. The fixed spacing and self-adhesive mesh makes installation of regularly shaped rooms quick and easy, whilst ensuring precision is maintained.

The underside of the fibreglass mesh has a pressure sensitive adhesive which securely binds the StickyMat to the floor, keeping it flat, ensuring the application of tile adhesive is snag free whilst allowing the system to be easily repositioned when required.



Components available from Warmup

Product Code	Description
SPM / 2SPM PFM / 2WPFM	Warmup StickyMat
WCI-6 / WCI-16	Warmup Ultralight
6IE-01-OB-DC 6IE-01-CW-LC	Warmup 6iE
RSW-01-WH-RG (ELM-01-WH-RG) RSW-01-OB-DC (ELM-01-OB-DC)	Warmup Element
ELT PB (ELT-01-PB-01) ELT CW (ELT-01-CW-01)	Warmup tempo
ACC-PRIMER	Warmup primer
DCM-E-25	Warmup perimeter strip
ACC-SELFLEVEL	Mapei Ultraplan Renovation Screed 3240. Fibre reinforced levelling compound

Additional components that may be required as part of the Warmup heating installation:

30 mA Residual Current Device (RCD/RCBO), required as part of all installations

Overcurrent protection, such as MCB's, RCBO's or fuses

Electrical housing, wall boxes and junction boxes

Electrical trunking/conduit for housing the power leads

Digital multi-meter required for testing the resistance of the heating cable and sensor

Electrical tape to secure the sensor

Step 1 - Electrical supply

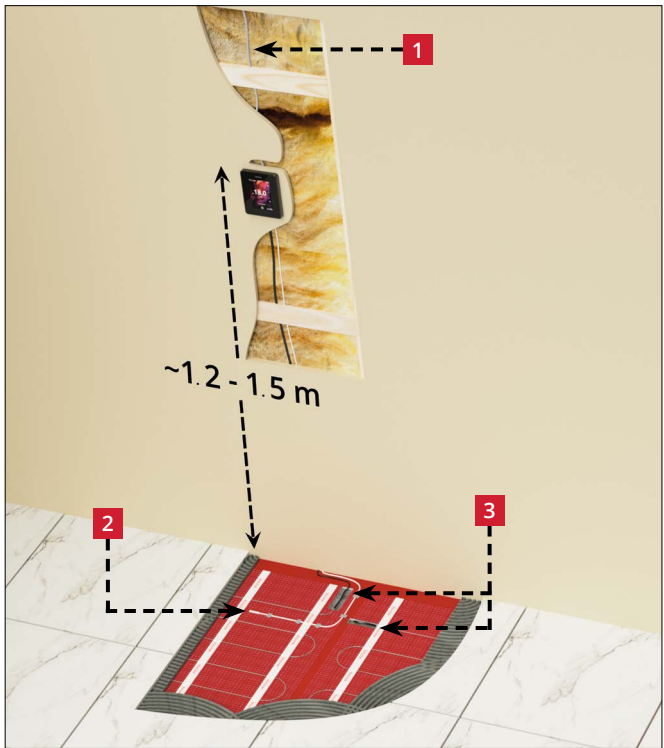

- 1** The supply to the thermostat **MUST** be protected by a 30mA RCD or RCBO at all times. Time delay RCD's or RCBO's must not be used. No more than 7.5 kW of heating should be connected to each 30 milliamp RCD or RCBO. For larger loads, use multiple RCD's or RCBO's.

The mat must be separated from the power supply by suitably rated circuit breaker that disconnects all poles with at least 3 mm contact separation. Use MCB's, RCBO's or fuses for this purpose.

Final connections to the main electricity supply **MUST** be completed by a qualified electrician.

- 2** Sensor installed (300 mm) centrally between two closest parallel runs of heating cable and away from other heat sources such as hot water pipes, lighting fixtures etc.
- 3** Manufactured joints recessed into subfloor so as they sit at the same height as the heater.

i If taking the power supply to the heaters from an existing 30 mA RCD/RCBO protected circuit, it should be calculated whether or not the circuit can handle the additional load and if necessary the supply must be de-rated to ≤ 16 amps.

i A junction box is required if more than two heaters are being connected to a single Warmup thermostat.

i When conducting an insulation resistance test on the supply to the thermostat the thermostat and heaters must be isolated or disconnected.

Step 1 - Electrical supply





Zoning information

In the case of bathroom installations, electrical regulations prohibit the installation of mains voltage products such as thermostats, contactors, fused spurs, isolators or junction boxes, within Zones 0 or 1.

Any mains voltage product fitted within Zone 2 must have a degree of protection at least of IPX4 or IPX5 if water jets are present.

It is common to install the thermostat outside of wet rooms in the adjacent connected room in circumstances where it is not practical to install the thermostat within the wet room.

When installed in this way, using only the sensor to control the heating, it is not possible to directly control the air temperature, only the surface temperature.

-  **All electrical connections must conform to the current national wiring regulations. Final connections to the main electricity supply MUST be completed by a qualified electrician.**
-  **Zone chart above is for UK and for illustrative purposes only. Please consult country specific wiring regulations for correct zoning information.**

Typical floor build-ups

Recommended subfloor - Tile floor finishes

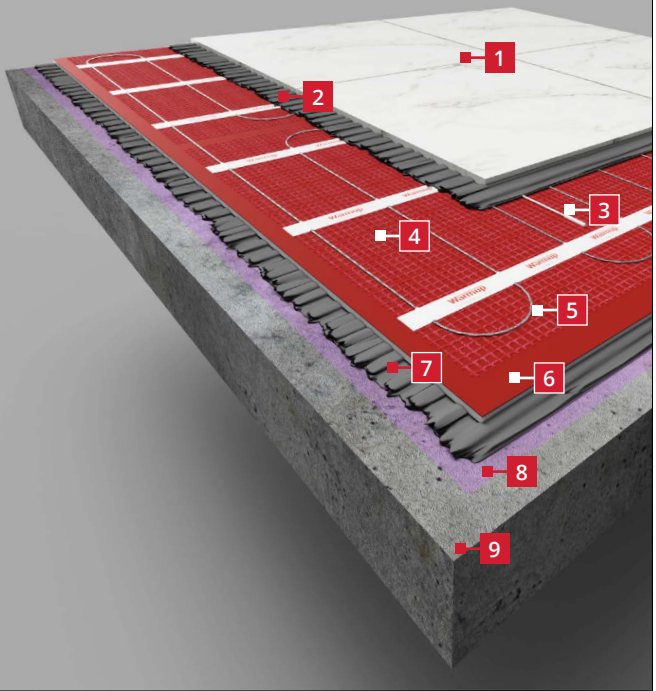

- | | |
|---|--|
| 1 | Tile floor finish |
| 2 | Flexible tile adhesive |
| 3 | Floor sensor
<i>Tab tape the sensor to the subfloor. Do not tape over the sensor tip!</i> |
| 4 | Fibreglass mesh with pressure sensitive adhesive
<i>Apply pressure to the mesh to ensure a secure bond to the subfloor</i> |
| 5 | Heating cable
<i>DO NOT cut at any stage!</i> |
| 6 | Warmup Ultralight (Optional)
<i>Adding Warmup Ultralight below StickyMat can help improve the response time of the system, particularly when installing over screed or concrete</i> |
| 7 | Flexible tile adhesive (Optional)
<i>Required if installing Warmup Ultralight</i> |
| 8 | Warmup primer
<i>Refer to tile adhesive manufacturers instructions for priming requirements</i> |
| 9 | Pre-insulated subfloor with a surface regularity of SR1*
<i>(The maximum permissible departure from a 2 m straight edge, resting under its own weight on the subfloor is 3 mm (SR1 Standard - BS 8204))</i> |

* If installing the optional Warmup Ultralight, refer to its installation manual for its sub floor requirements.

Typical floor build-ups

Recommended subfloor - All floor finishes

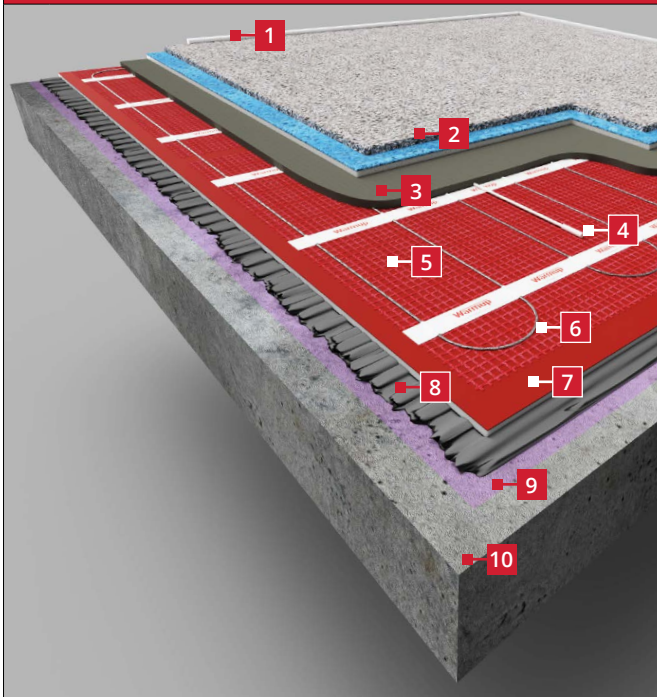

- | | |
|----|--|
| 1 | Perimeter strip
<i>To allow for differential movement between finished floor level and walls</i> |
| 2 | Floor finish |
| 3 | 10 mm levelling compound
<i>Levelling compound used must be compatible with electric underfloor heating. The levelling compound must be applied as a single layer.</i> |
| 4 | Floor sensor
<i>Tab tape the sensor to the subfloor. Do not tape over the sensor tip!</i> |
| 5 | Fibreglass mesh with pressure sensitive adhesive
<i>Apply pressure to the mesh to ensure a secure bond to the subfloor</i> |
| 6 | Heating cable
<i>DO NOT cut at any stage!</i> |
| 7 | Warmup Ultralight (Optional)
<i>Adding Warmup Ultralight below StickyMat can help improve the response time of the system, particularly when installing over screed or concrete</i> |
| 8 | Flexible tile adhesive (Optional)
<i>Required if installing Warmup Ultralight</i> |
| 9 | Warmup primer
<i>Refer to tile adhesive manufacturers instructions for priming requirements</i> |
| 10 | Pre-insulated subfloor with a surface regularity of SR1*
<i>(The maximum permissible departure from a 2 m straight edge, resting under its own weight on the subfloor is 3 mm (SR1 Standard - BS 8204))</i> |





* If installing the optional Warmup Ultralight, refer to its installation manual for its sub floor requirements.

Step 2 - Subfloor considerations

To prevent excessive heat loss through the floor, StickyMat should only be laid over insulated or intermediate subfloors.

The subfloor must be solid, structurally sound and dimensionally stable. The maximum permissible departure from a 2 m straight edge, resting under its own weight on the subfloor is 3 mm. (SR1). If necessary an appropriate smoothing or levelling compound should be applied.

The surface StickyMat is being applied to must be smooth and primed with Warmup primer such that a clean and continuous bond can be made. Warmup primer requires that the subfloor is dry, frost-free, solid, weight-bearing and dimensionally stable. It must be free from contaminants that may impede adhesion such as dust, dirt, oil, grease, release agents, loose material or surface laitance.

-  Subfloors previously covered in vinyl, cork or carpeting: all old flooring and glues must be removed.
-  Any materials on or within the subfloor must be suitable for supporting electric underfloor heating systems. If using temperature sensitive materials beneath StickyMat, such as damp proofing or tanking systems, contact the manufacturer for advice.
-  If installing StickyMat over Warmup Ultralight, the surface of the Ultralight does not need priming if it is kept clean.
-  Where ceramic tiles are to be used concrete and timber subfloors should be prepared for tiling in accordance with local tiling standards.
-  Do not commence installation of the StickyMat without ensuring that the resulting floor construction will meet the requirements of the floors intended use and its finish.

Step 3 - Subfloor preparation



- The subfloor must be pre-insulated unless it is an intermediate floor.
- The subfloor must be solid, structurally sound and dimensionally stable. The maximum permissible departure from a 2 m straight edge, resting under its own weight on the subfloor is 3 mm. (SR1).



- Referring to its instructions, prime the subfloor using Warmup primer.



- We recommend installing Warmup Ultralight for optimum performance referring to its instructions.
- If planning to self-level over the StickyMat system then install perimeter strip around the perimeter of the room to allow for differential movement between finished floor level and walls.

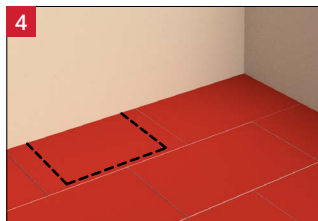





- Mark out the floor with a permanent marker showing where fixtures and other unheated areas are going to be.

Step 4 - Layout Planning

Modifying the system

In order to fit the heating mat into a specific area, it may be necessary to cut and turn the heating mat or remove the cable from the mesh and loose lay around obstacles. Please refer to the examples below for guidance.

-  When cutting and turning take care not to cut or damage the heating cable.
-  Maintain a minimum of 50 mm between any heating cable removed from the mesh.
-  Please take a moment to double-check that the plan has the proper room dimensions and that the correct size and proper number of systems has been specified.
-  When laying two or more heating mats, ensure all coldtails reach the thermostat.

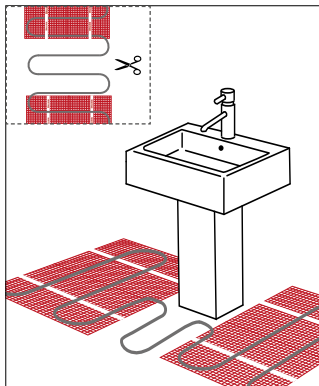
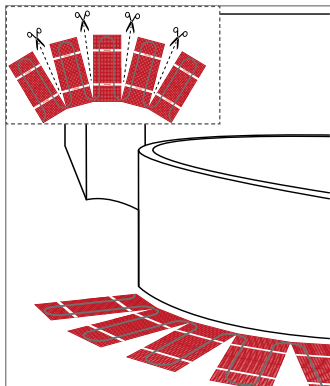
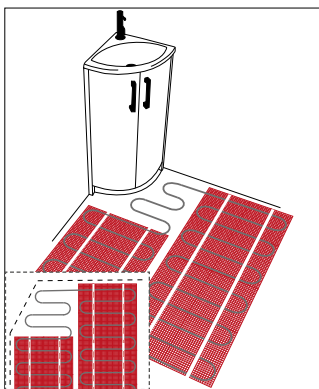
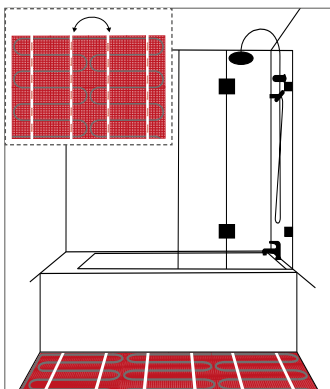

Step 4 - Layout planning



A plan of the heating mat layout is required as part of the control card so that any cutting or drilling after tiling will not result in injury or damage.

Before beginning

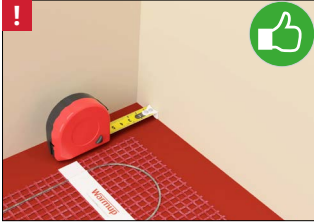

- Maintain a spacing of 40 mm between the system and the perimeter of the room or any unheated areas.

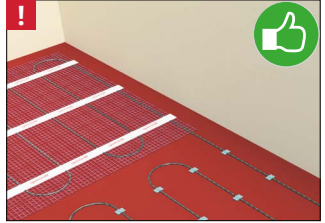

- Ensure that there is a minimum of 50 mm between any heating cable removed from the mesh and that the cable is away from the influence of other heat sources, such as heating and hot water pipes, lighting fixtures or chimneys at all times.

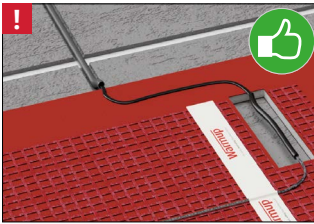

- Where a heated floor is divided by expansion joints, individual systems should be used to heat each area. The cold tail may cross the expansion joint within a 300 mm long conduit as shown.

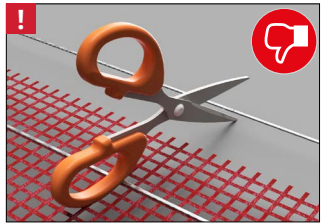

- The heating cable must not be cut, shortened, extended or left in a void, it must be fully installed within the layer of tile adhesive.

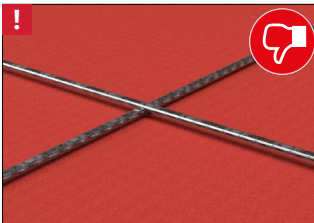

- When installing the system DO NOT cross the heating cable over another run, over coldtails or the sensor. This will cause overheating and will damage the heating cable.



- The system should not be installed on irregular surfaces such as on stairs or up walls.

Step 5 - StickyMat installation

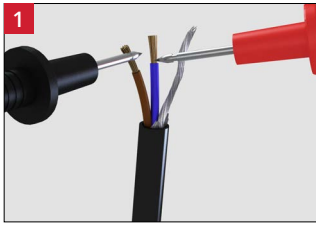

- Measure and record the resistance of the system in the "resistance before" column of the control card, supplied as part of this installation guide.
- Stop installation immediately and contact Warmup if its resistance falls outside the range set out in the reference resistance band table.

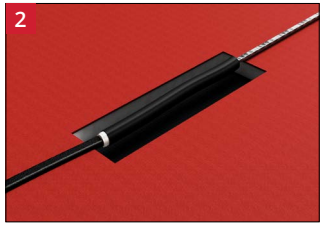

- Place the coldtail on the floor. Cut a section in the subfloor for the coldtail joint so that it sits at the same height as the heating mat.
- Secure the coldtail using tabs of electrical tape as necessary.



DO NOT tape over the coldtail joint. It must be fully embedded within the tile adhesive or levelling compound being laid over.

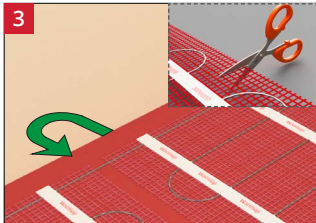

- Begin laying the system, cutting the mesh and turning the heating mat to fit the floor area. Secure the system to the subfloor, pressing the mesh onto the subfloor triggering the pressure sensitive adhesive.
- If flipping and turning the system secure using the double-sided tape.
- **DO NOT** install the system in temperatures less than -10°C .

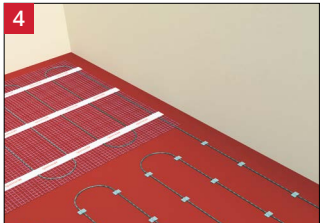

- To install the system in awkward areas the heating cable can be removed from the mesh and fixed in place with tabs of tape, taking care to remove air cavities.
- The heating cable should be evenly spaced to prevent thermal striping.



Ensure there is a minimum of 50 mm spacing between parallel heating cables.

Step 5 - StickyMat installation

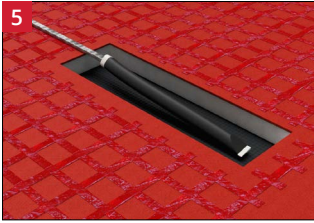

- At the end of the heating cable, there is a termination joint. As with the coldtail joint at the beginning of the heating cable, this joint will have to be cut into the subfloor so that it sits at the same height as the system.

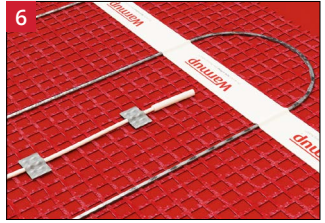

- Install the sensor at least 300 mm into the heated area it will be controlling. It should be located centrally between the two closest parallel runs of heating cable and not in an area influenced by other heat sources.
- The sensor can be secured to the subfloor with tabs of tape.



DO NOT tape over the termination joint. It must be fully embedded within the tile adhesive or levelling compound being laid over.



DO NOT tape over the sensor tip it must be in full contact with the heated tile adhesive or levelling compound.

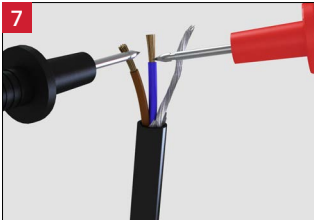

- Measure the resistance of the system and verify it is still in line with the resistance before reading previously taken.
- Stop installation immediately and contact Warmup if its resistance has changed significantly or if it falls outside the range set out in the reference resistance band table.

Step 6 - Select floor covering



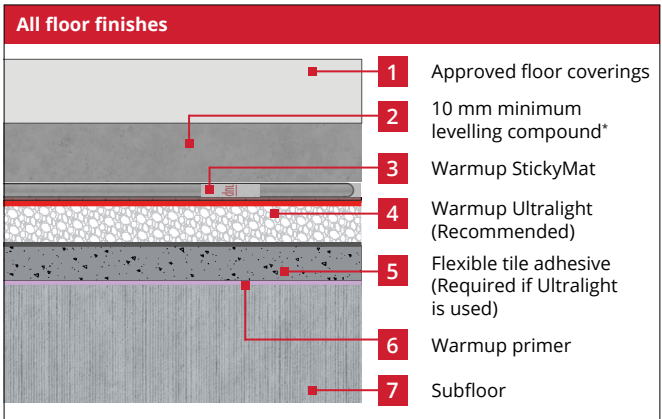
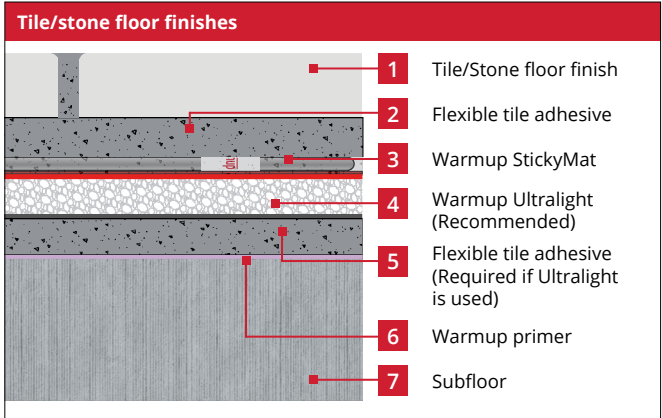

Before installing any floor finish, adhesive or levelling compound over StickyMat, the installation requirements of each must be checked to ensure compatibility with underfloor heating.

Where used, levelling compounds must be suitable for single pour installation depths of at least 10 mm.



* This method can be used to create a floor surface suitable for most floor finishes and when forming a drainage slope within a wetroom. The levelling compound, when used, must be applied as a single layer. Additional layers of levelling compound must not be added. Check with flooring manufacturer for suitability with floor heating.

Step 7 - Lay floor covering - Tile floor finishes

-  Underfloor heating performs the most efficiently with conductive, low resistance floor finishes such as stone and tiles. The maximum thermal resistance of the floor should not exceed 0.15 [m²K/W].
-  Ensure that the tile adhesive used is compatible with underfloor heating.



- Cover the installation with a full bed of flexible tile adhesive using a notched trowel. Take care not to damage or dislodge the heating cable. If using tiles smaller than 90 mm cover the installation with a levelling compound first.
- Carefully lay the tiles and press into the adhesive bed.

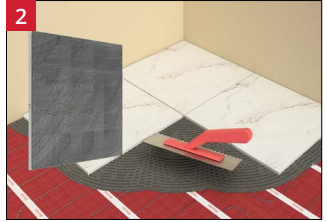

- After laying the first tile remove and ensure the tile is getting a full coverage of thinset from the application.
- Ensure the width of the grout line is in line with the manufacturers instructions for the size and type of tile being used. Tiles must not be removed once the thinset has set, doing so will damage the system.



- Grout the floor as soon as possible as per the ceramic tile adhesive manufacturer's instructions.

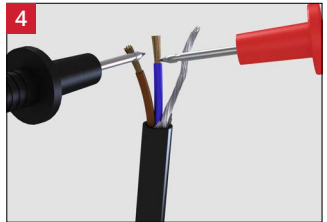

- When the tiles have been installed, conduct another resistance test to ensure the sensor and heating mat have not been damaged and record in the control card.



DO NOT switch on the system until the tile adhesive and grout has fully cured. DO NOT use the heating mat to accelerate the drying process of the adhesive or levelling compound.

Step 7 - Lay floor covering - All floor finishes

- i** Before installing the floor finish its suitability for use with underfloor heating and its maximum operating temperature should be checked against required operating conditions.

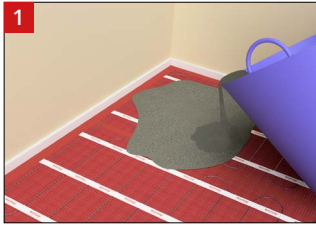

- If planning to install wood, carpet or vinyl over the system a single layer of self levelling compound is required (**minimum thickness: 10 mm**) over the system. Ensure that the heating mat, including joints are completely covered. It is important that the levelling compound is suitable for use with the underfloor heating.

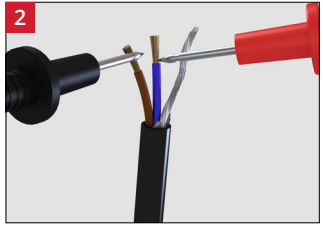

- When the levelling compound has been installed, conduct another resistance test to ensure the sensor and heating mat have not been damaged and record in the control card.

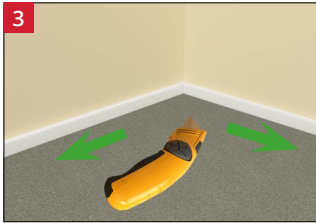

- The 30 mm tall perimeter strip should finish just proud of the levelling compound but can be trimmed back flush with a utility knife if required.

Step 8 - Connect the thermostat

i Install the thermostat in accordance with its installation instructions

Instructions for fitting Warmup® thermostats can be found inside the thermostat box. The thermostat should be connected to the main electrical supply by suitably rated circuit breaker that disconnects all poles with at least 3 mm contact separation. Use MCB's, RCBO's or fuses for this purpose.

The heating mat power cable consists of conductors coloured brown (live), blue (neutral) and earth braid. If installing more than one heating mat a junction box will be required. Final connections to the main electricity supply MUST be completed in accordance with the wiring regulations by a qualified electrician.

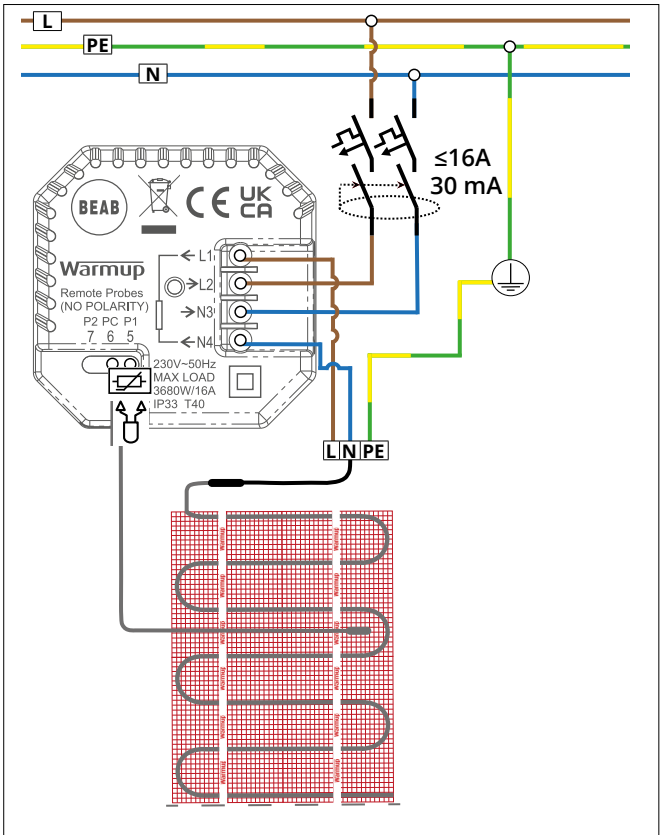

Step 8 - Connect the thermostat (Load exceeding 16 Amps)

Warmup thermostats are rated for a maximum of 16 amps (3680 W at 230 V). A contactor must be used to switch loads exceeding 16 amps.

If using contactors which exceed 16 amps, the supply to the system must be de-rated to ≤ 16 amps to provide overcurrent protection. Multiple external relays can be used for larger loads. Please see wiring diagram below.

- i** Wiring diagram is for illustrative purposes only. Please consult country specific wiring regulations for correct wiring information.
- i** Thermostat wiring with a contactor must be completed by a qualified electrician.

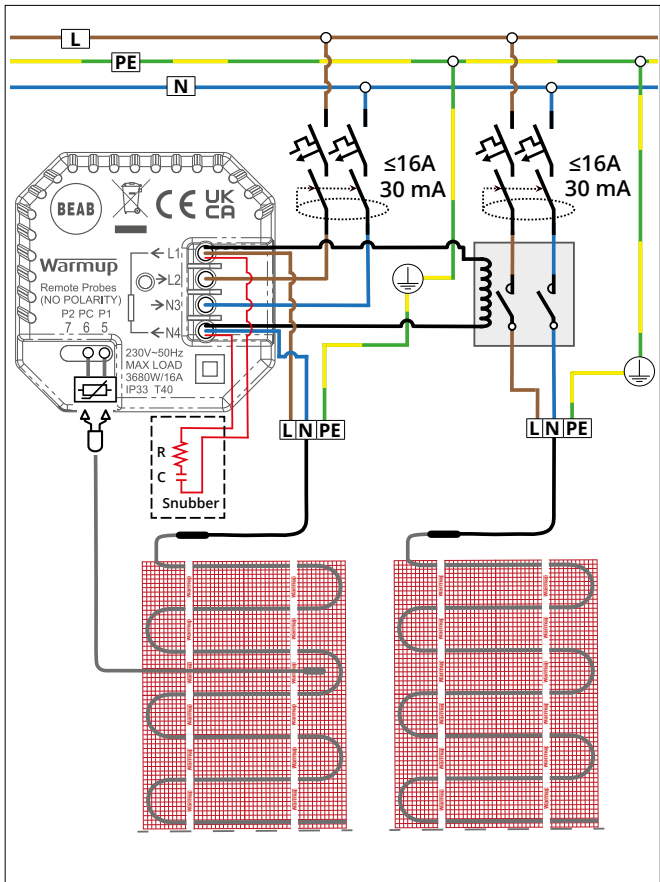

Warmup



ElementTM WiFi Thermostat

Smart Heating. Simplified.

Troubleshooting

HEATING ISSUE 1 - The floor does not heat up

Instructions which are shaded must be completed by a qualified electrician

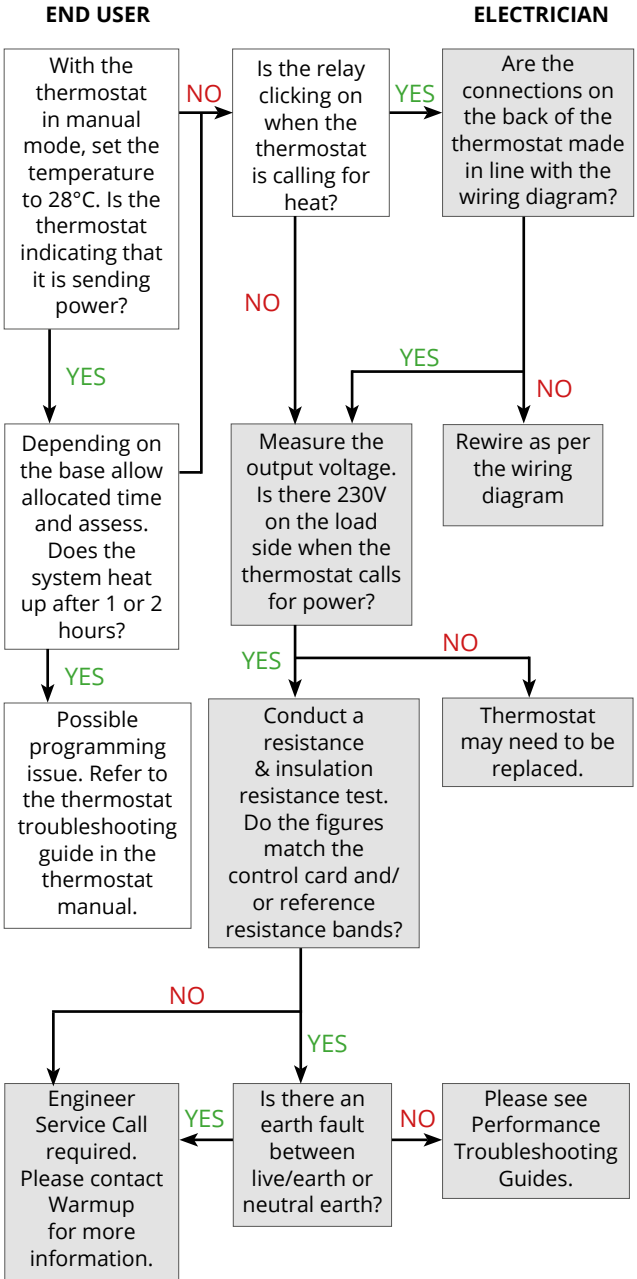

HEATING ISSUE 2 - The heating mat trips the RCD

Instructions which are shaded must be completed by a qualified electrician

ELECTRICIAN

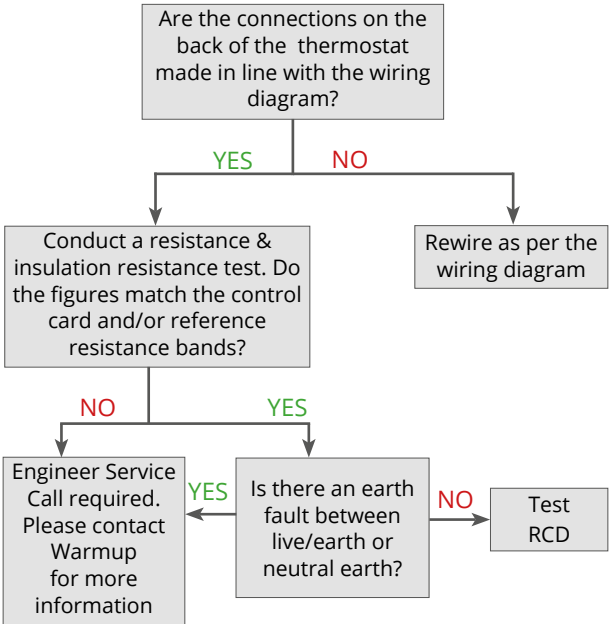

ISSUE 1 - My floor is getting too hot

PROBLEM		SOLUTION
1	The floor temperature settings on the thermostat may be incorrect.	Check the thermostat settings ensuring that it is controlling the floor surface temperature and that the set target and limiting temperatures are correct.
2	The floor sensor may be poorly positioned, if so the thermostat will be displaying a floor temperature that is not indicative of the floor surface temperature.	Recalibrate the floor sensor in the thermostat settings.
3	The thermostat may be set in regulator mode with the duty cycle set too high.	If the thermostat cannot be set to reference a floor sensor, reduce the regulation value to its minimum selectable value. With the heating active, incrementally increase the setting at an hourly interval until the required floor surface temperature is achieved.





ISSUE 2 - My floor does not get up to temperature

PROBLEM		SOLUTION
1	Underfloor heating is normally designed to heat floors to up to 9°C above the design room air temperature, which is typically 29°C. Delicate floor finishes, such as vinyl and some timbers, may be limited to 27°C. Our hand and foot temperature is normally similar to this, at around 29 - 32°C, so the heated floor will feel slightly cooler than touching hands together.	To raise the floor temperature, such that it feels warm, it is permissible to set it up to 15°C higher than the design room air temperature. The higher heat output of the floor may overheat the room, making it uncomfortable. The manufacturer of the floor finish should be consulted to ensure compatibility with the chosen temperature before making any changes to the thermostat settings.
	Refer to points 1, 2 & 3 in the "My floor is getting too hot" above, as each issue can also be the cause of under heating a floor.	
2	If the thermostat is controlling the heating using the air temperature, with a floor temperature limit then the floor may be turned off before it reaches its limit.	This is normal as the thermostat is preventing the room air temperature from becoming overheated.
3	The heating system may be uninsulated. If the heating mat has not been installed over a layer of insulation, it will be actively heating the subfloor as well as the floor finish. The warm up period of the floor will therefore be slower as the system is heating a much greater mass. It could take several hours if it is installed directly on a thick layer of uninsulated concrete.	If the thermostat has an optimised start feature, ensure it is enabled so that the thermostat can compensate for the mass of the floor. If the thermostat does not have an optimised start feature, measure the time taken for the floor to warm up and adjust the heating start time to compensate.

Performance troubleshooting

4	The heat output of the installed system may not be sufficient. The system will require a power output of approximately 10 W/m ² for every degree warmer you require the floor to be than the air. This is in addition to any heat loss downwards through the subfloor	If the room air temperature is also lower than desired, supplementary heating may be required to overcome the room heat losses. If access is available to the underside of the subfloor, installing insulation within the floor will reduce the amount of heat lost through the floor.
5	Floor coverings such as carpets, underlays and timber are thermally resistive and will reduce the achievable floor surface temperature. They may also require the floor sensor to be recalibrated.	Floor finish combinations with a thermal resistance of more than 0.15 m ² K/W or 1.5 tog are not recommended and we recommend that a less resistive floor finish. Floor finish combinations with a thermal resistance of more than 0.25 m ² K/W or 2.5 tog are not permitted.

ISSUE 3 - I am getting patchy heat across my floor

	If the subfloor varies across the floor, the amount of heat absorbed by it and lost through it will affect the floor surface temperatures differently above each case.
	If the floor covering over the underfloor heating changes, each floor finishes characteristics will affect the warm up period and the achievable surface temperature.
	Hot water pipes under the floor could cause parts of the floor to seem warmer than others.
	Irregularly spaced cables will cause the floor to be warmer above the closer cables and cooler where the cables are spaced further apart.

Testing information

i Each system and sensor must be tested before they are installed, once they have been laid but before tiling or laying levelling compound and again before they are connected to the thermostat. The resistance (ohms) should be measured and recorded in the control card at the end of the manual.

i Due to the high resistance of the heating element, it may not be possible to get a continuity reading from the heating cable and as such, continuity testers are not an acceptable substitution for testing. When checking resistance, make sure hands do not touch the meter's probes as the measurement will include internal body resistance and render the measurement inaccurate. If expected results are not achieved, please contact Warmup for guidance.

Heating mat resistance test

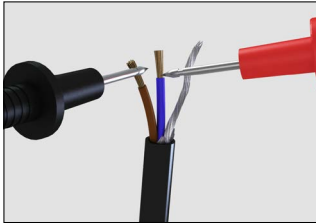

- Set a multimeter or ohmmeter to record resistance in the range of 0-500 Ω . Measure the resistance across the live (brown) and neutral (blue) wires. Ensure the measured resistance is within the reference resistance band for the cable size being tested.

Earth fault test

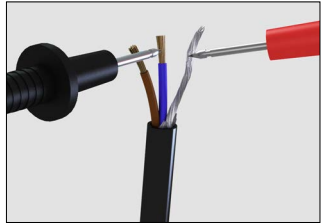

- Set a multimeter or ohmmeter to record resistance in the range of 1 M Ω or greater if available. Measure the resistance across the live (brown) and neutral (blue) wires to the earth braid.

Ensure the measured resistance is showing as greater than 500 M Ω or infinite if the meter cannot read this high.

- Set an insulation resistance tester to 500 V DC. Measure the resistance across the live (brown) and neutral (blue) wires to the earth braid wire. Ensure the measured resistance is showing greater than 500 M Ω to indicate a pass.

Testing information

Sensor resistance test

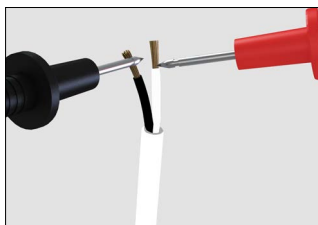

- Ensure that the sensor is tested before the final finish has been fitted. Warmup thermostats typically use a 10 k Ω sensor. Please refer to the thermostat manual for further details.

The expected resistance depending on temperature is listed below.

Sensor resistance by temperature - NTC10K

Temperature	Resistance	Temperature	Resistance
0 °C	32.5 k Ω	16 °C	15.0 k Ω
2 °C	29.4 k Ω	18 °C	13.7 k Ω
4 °C	26.6 k Ω	20 °C	12.5 k Ω
6 °C	24.1 k Ω	22 °C	11.4 k Ω
8 °C	21.9 k Ω	24 °C	10.5 k Ω
10 °C	19.9 k Ω	26 °C	9.6 k Ω
12 °C	18.1 k Ω	28 °C	8.8 k Ω
14 °C	16.5 k Ω	30 °C	8.1 k Ω

Technical specifications

Warmup StickyMat

Product code	SPM* / 2SPM* PFM* / 2WPFM*
Operating voltage	230 V AC: 50 Hz
Connection	3.0 m long coldtail Flat 2 core cable with earth braid
IP rating	X7
Output rating	150 W/m ² (SPM, PFM) / 200 W/m ² (2SPM, 2WPFM)
Heating cores	Dual core, multi-strand heating element
Inner / Outer insulation	ETFE
Cable sheath	Translucent
Cable spacing	80 mm (+/-3 mm)
Mesh	Sticky pressure sensitive fibreglass mesh
Mesh colour	Red (150 W/m ²) / Blue (200 W/m ²)
Earth protection	Metal braiding surrounding heating cores
Minimum installation temperature	-10 °C

Cable section

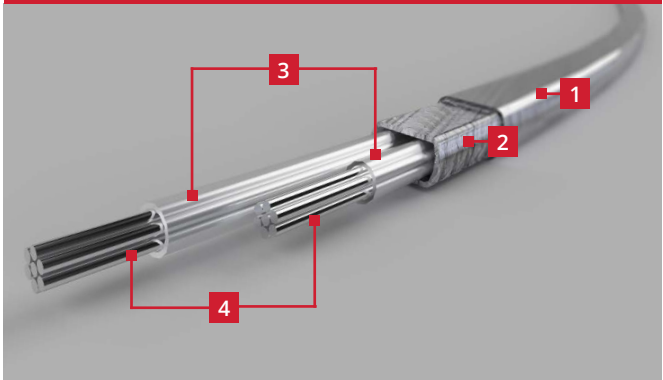

1	ETFE outer insulation
2	Earth braiding surrounding heating cores
3	ETFE inner insulation
4	Dual core, multi-strand heating element

Technical specifications

StickyMat 150 W/m² system

Product code	Size (m)	Power (W)	Current (A)	Resistance (Ω)	Resistance Band (Ω)	
SPM/PFM 1 m ²	0.5 x 2	150	0.65	352.7	335.0	- 370.3
SPM/PFM 1.5 m ²	0.5 x 3	225	0.98	235.1	223.4	- 246.9
SPM/PFM 2 m ²	0.5 x 4	300	1.30	176.3	167.5	- 185.2
SPM/PFM 2.5 m ²	0.5 x 5	375	1.63	141.1	134.0	- 148.1
SPM/PFM 3 m ²	0.5 x 6	450	1.96	117.6	111.7	- 123.4
SPM/PFM 3.5 m ²	0.5 x 7	525	2.28	100.8	95.7	- 105.8
SPM/PFM 4 m ²	0.5 x 8	600	2.61	88.2	83.8	- 92.6
SPM/PFM 4.5 m ²	0.5 x 9	675	2.93	78.4	74.5	- 82.3
SPM/PFM 5 m ²	0.5 x 10	750	3.26	70.5	67.0	- 74.1
SPM/PFM 6 m ²	0.5 x 12	900	3.91	58.8	55.8	- 61.7
SPM/PFM 7 m ²	0.5 x 14	1050	4.57	50.4	47.9	- 52.9
SPM/PFM 8 m ²	0.5 x 16	1200	5.22	44.1	41.9	- 46.3
SPM/PFM 9 m ²	0.5 x 18	1350	5.87	39.2	37.2	- 41.1
SPM/PFM 10 m ²	0.5 x 20	1500	6.52	35.3	33.5	- 37.0
SPM/PFM 11 m ²	0.5 x 22	1650	7.17	32.1	30.5	- 33.7
SPM/PFM 12 m ²	0.5 x 24	1800	7.83	29.4	27.9	- 30.9
SPM/PFM 15 m ²	0.5 x 30	2250	9.78	23.5	22.3	- 24.7

StickyMat 200 W/m² system

Product code	Size (m)	Power (W)	Current (A)	Resistance (Ω)	Resistance Band (Ω)	
2SPM/2WPFM 0.5m ²	0.5 x 1	100	0.43	529.0	502.6	- 555.5
2SPM/2WPFM 1m ²	0.5 x 2	200	0.87	264.5	251.3	- 277.7
2SPM/2WPFM 1.5m ²	0.5 x 3	300	1.30	176.3	167.5	- 185.2
2SPM/2WPFM 2 m ²	0.5 x 4	400	1.74	132.3	125.6	- 138.9
2SPM/2WPFM 2.5m ²	0.5 x 5	500	2.17	105.8	100.5	- 111.1
2SPM/2WPFM 3m ²	0.5 x 6	600	2.61	88.2	83.8	- 92.6
2SPM/2WPFM 3.5m ²	0.5 x 7	700	3.04	75.6	71.8	- 79.4
2SPM/2WPFM 4m ²	0.5 x 8	800	3.48	66.1	62.8	- 69.4
2SPM/2WPFM 4.5m ²	0.5 x 9	900	3.91	58.8	55.8	- 61.7
2SPM/2WPFM 5m ²	0.5 x 10	1000	4.35	52.9	50.3	- 55.5
2SPM/2WPFM 6m ²	0.5 x 12	1200	5.22	44.1	41.9	- 46.3
2SPM/2WPFM 7m ²	0.5 x 14	1400	6.09	37.8	35.9	- 39.7
2SPM/2WPFM 8m ²	0.5 x 16	1600	6.96	33.1	31.4	- 34.7
2SPM/2WPFM 9m ²	0.5 x 18	1800	7.83	29.4	27.9	- 30.9
2SPM/2WPFM 10m ²	0.5 x 20	2000	8.70	26.5	25.1	- 27.8
2SPM/2WPFM 15m ²	0.5 x 30	3000	13.04	17.6	16.8	- 18.5

Floor sensor setting for target heat output

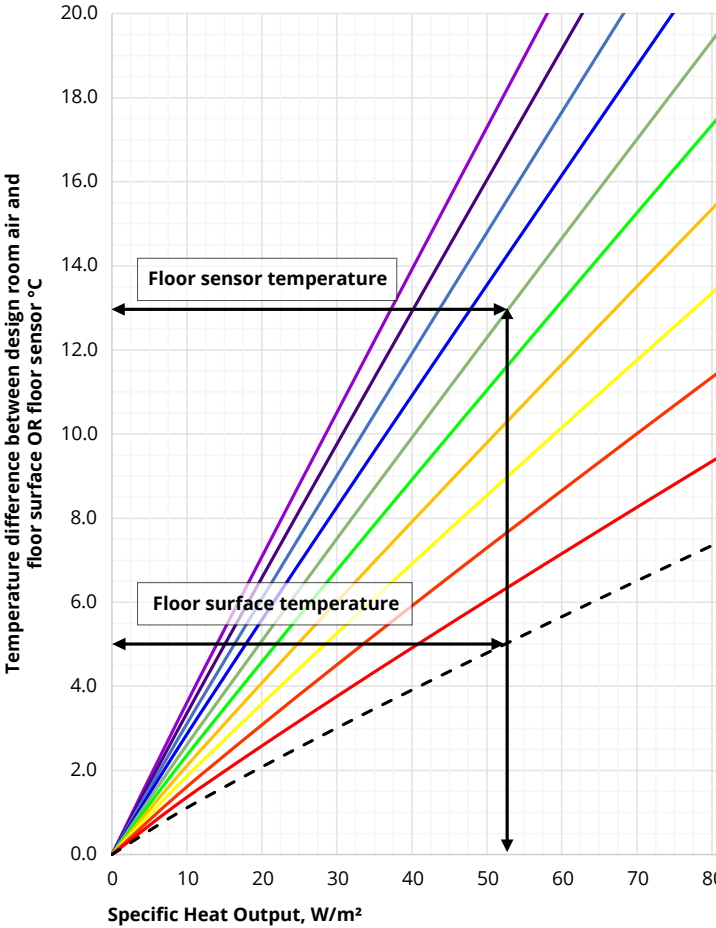

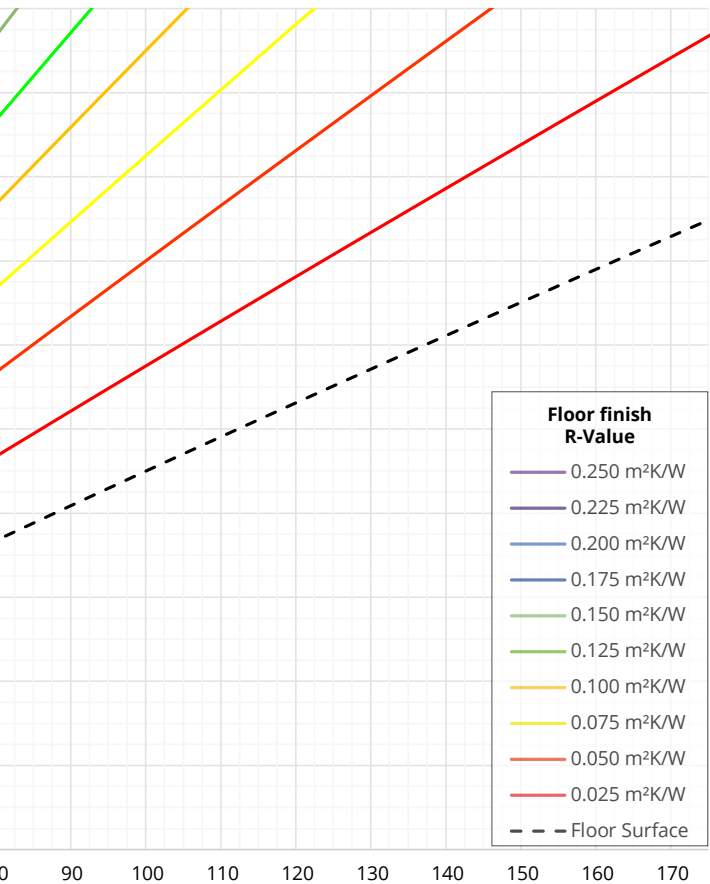

Using the graph above it is possible to get the specific heat output of an electric underfloor heating system based on the temperature difference between the design room air temperature and the floor surface or floor sensor temperature by floor finish.

The example above shows a design room air temperature of 20 °C and floor surface temperature of 25 °C. Based on the temperature difference of 5°C the resulting heat output would be 52.5 W/m². Based on a 0.150 m²K/W (1.5 Tog) floor finish the floor sensor would have to be set to 33 °C to achieve this heat output.



Specific Heat Output, W/m²

-  The design floor surface temperature difference should not be more than 9 °C in occupied areas, 15 °C in unoccupied areas.
-  Heat output is limited by the floor finish resistance combined with the maximum probe setting of 40 °C.
-  Temperature limits of the floor finish or its adhesive may adversely limit the design heat output.



Warmup® underfloor heating is guaranteed by Warmup plc (“Warmup”) to be free from defects in materials and workmanship under normal use and maintenance, and is guaranteed to remain so subject to the limitations and conditions described below. StickyMat is guaranteed for the LIFETIME of the floor covering under which it is fitted, except as provided below (attention is drawn to the exclusions listed at the end of this guarantee).

This Lifetime guarantee applies:

- 1 Only if the unit is registered with Warmup within 30 days after purchase. Registration can be completed online at **www.warmup.ie**. In the event of a claim, proof of purchase is required, so keep invoice(s) and receipt(s) - such invoice(s) and receipt(s) should state the exact model that has been purchased;
- 2 Only if the system has been earthed and protected by a Residual Current Device (RCD/RCBO) at all times.



All Warmup warranties are voided if the floor covering over Warmup systems(s) are damaged, lifted, replaced, repaired or covered with subsequent layers of flooring. The warranty period begins on the date of purchase. During the period of the guarantee Warmup will arrange for the system to be repaired or (at its discretion) have parts replaced free of charge or issue a refund for the product only. The cost of the repair or replacement is the only remedy under this guarantee which does not affect statutory rights.

Such cost does not extend to any cost other than direct cost of repair or replacement by Warmup and does not extend to costs of relaying, replacing or repairing any floor covering or floor. If the system fails due to damage caused during installation or tiling, this guarantee does not apply. It is therefore important to check that the system is working (as specified in the installation manual) prior to tiling.

WARMUP PLC SHALL IN NO EVENT BE LIABLE FOR INCIDENTAL OR CONSEQUENTIAL DAMAGES, INCLUDING BUT NOT LIMITED TO EXTRA UTILITY EXPENSES OR DAMAGES TO PROPERTY.

Warmup plc is not responsible for:

- 1 Damage or repairs required as a consequence of faulty installation or application.
- 2 Damage as a result of floods, fires, winds, lightning, accidents, corrosive atmosphere or other conditions beyond the control of Warmup plc.
- 3 Use of components or accessories not compatible with this unit.
- 4 Products installed outside of any country or territory within which Warmup operates.
- 5 Normal maintenance as described in the installation and operating manual, such as cleaning thermostat.
- 6 Parts not supplied or designated by Warmup.
- 7 Damage or repairs required as a result of any improper use, maintenance, operation or servicing.
- 8 Failure to start due to interruption and/or inadequate electrical service.
- 9 Any damage caused by frozen or broken water pipes in the event of equipment failure.
- 10 Changes in the appearance of the product that does not affect its performance.



SafetyNet™ installation guidelines: If the system is damaged before laying the floor covering, return the damaged product to Warmup within in 30 days along with the original dated sales receipt.

WARMUP WILL REPLACE ANY PRE-TILED SYSTEM (MAXIMUM 1 SYSTEM) WITH ANOTHER OF THE SAME MAKE AND MODEL - FREE.

- 1** Repaired products carry a 5 year warranty only. Under no circumstances is Warmup responsible for the repair or replacement of any tiles / floor covering which may be removed or damaged in order to affect the repair.
- 2** The SafetyNet™ Installation Guarantee does not cover any other type of damage, misuse or improper installation due to improper adhesive or subfloor conditions. Limit of one free replacement system per customer or installer.
- 3** Damage to the system that occurs after tiling, such as lifting a damaged tile once it has set, or subfloor movement causing floor damage, is not covered by the SafetyNet™ Guarantee.

Warmup® warranty registration
www.warmup.ie

Layout plan



Draw a plan showing the layout and location of the heating mat/cable(s)

A large rectangular grid consisting of 20 columns and 30 rows of small squares, intended for drawing a layout plan.

Control card

Warning!

Radiant direct floor heating system.

Risk of shock or fire

Electric-wiring and heating panels contained within the floor. DO NOT penetrate with nails, screws, or similar devices. DO NOT restrict the thermal emission of the heated floor.



Heater location

Total wattage

Checklist - Installer					
Is the heating mat, including manufactured joints, underneath the floor covering embedded in adhesive/levelling compound?					<input type="checkbox"/>
Can you confirm that the manufactured joints and floor sensor tip, have NOT been taped over during installation?					<input type="checkbox"/>
Model	Heater resistance			Insulation resistance test	Sensor resistance
	Before	During	After		
Installer name, company:					
Installer signed: Date:					

Checklist - Electrician					
Is the heating mat is protected a dedicated 30 mA RCD/RCBO or an existing RCD/RCBO? Time delay RCD's must not be used.					<input type="checkbox"/>
Is the mat separated from the power supply by suitably rated circuit breaker that disconnects all poles with at least 3 mm contact separation, for example, MCB's, RCBO's or fuses?					<input type="checkbox"/>
Model	Heater resistance			Insulation resistance test	Sensor resistance
	Before	During	After		
Electrician name, company					
Electrician signed Date:					

This form must be completed as part of the Warmup Guarantee. Ensure that the resistance values are as per the instruction manual. This control card, layout plan and installation manual must be left permanently fixed near the consumer unit.

Warmup IE T: 1 800 937 429 www.warmup.ie

Warmup plc ■ 704 Tudor Estate ■ Abbey Road ■ London ■ NW10 7UW ■ UK

Warmup GmbH ■ Ottostraße 3 ■ 27793 Wildeshausen ■ DE





Warmup

www.warmup.ie

ie@warmup.com

Tel: 1 800 937 429

Warmup

The WARMUP word and associated logos are trade marks.
© Warmup Plc. 2022 – Regd.™ Nos. 1257724, 4409934, 4409926,
5265707. E & OE.

Warmup plc ■ 704 Tudor Estate ■ Abbey Road ■ London ■ NW10 7UW ■ UK

Warmup GmbH ■ Ottostraße 3 ■ 27793 Wildeshausen ■ DE

Warmup - IM - StickyMat - V1.5 - 2022-04-25_IE